

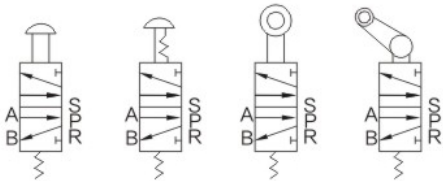

符号

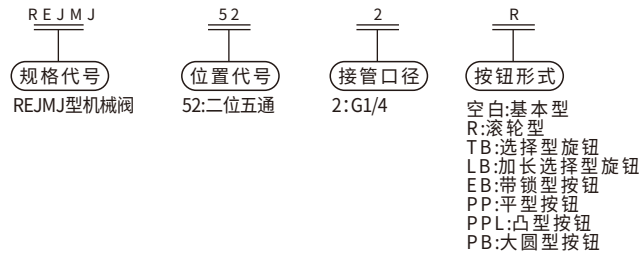

型号表示方法



规格

项目/型号	REJMJ-00	REJMJ-07	REJMJ-05	REJMJ-06	REJMJ-04	REJMJ-03	REJMJ-01	REJMJ-02
使用介质	空气(经40μm滤网过滤)							
动作方式	直动式							
接管口径	08:G1/4							
使用压力	0~0.8Mpa(0~114Psi)							
工作温度	-5~60°C(28~140° F)							
润滑	不需要							

外形尺寸图(毫米)

基本型

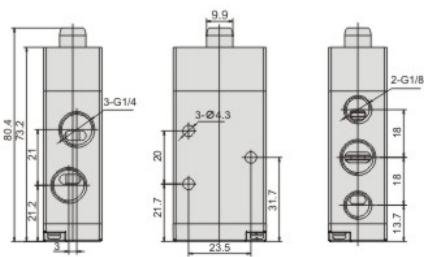

带锁型按钮

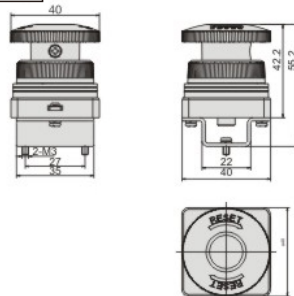

平型按钮

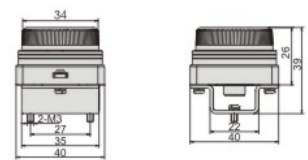

滚轮型

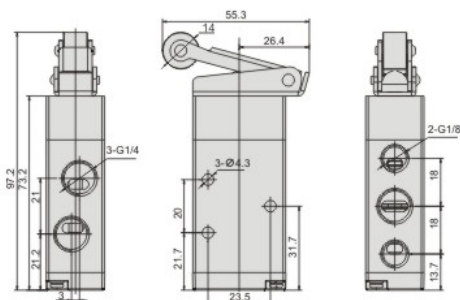

大圆型按钮

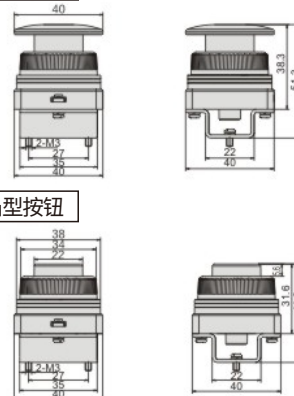

选择型旋钮

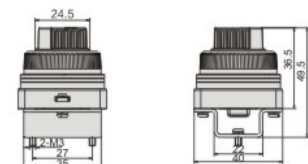

凸型按钮

